

RSCOMMANDER

Versatile Software Tool for Rohde & Schwarz Instruments

Products:

- ▶ R&S®FSW
 - ▶ R&S®SMW200A
 - ▶ R&S®CMW500
 - ▶ R&S®FPL1000
 - ▶ R&S® FPC1000
 - ▶ R&S® ZVA
 - ▶ R&S® ZNL
 - ▶ R&S® SMA1000B
 - ▶ R&S® VTC
 - ▶ R&S® BTC
 - ▶ R&S® RTH
 - ▶ R&S® RTO2000
 - ▶ R&S® RTM3000
- And more...

Frederic Schütze, Ottmar Gerlach, Dieter Bues | 1MA074 | Version 19e | 10.2021

Note:

Please find the most up-to-date document on our homepage

<https://www.rohde-schwarz.com/appnote/1MA074>

This document is complemented by software. The software may be updated even if the version of the document remains unchanged

ROHDE & SCHWARZ

Make ideas real



Contents

1	Overview.....	3
2	Software	4
2.1	Features	4
2.2	Requirements	4
2.3	Installation	4
2.3.1	Windows.....	4
2.3.2	macOS	4
3	Connecting the Instruments	5
4	Getting Started.....	7
5	Software Description	9
5.1	Main screen.....	9
5.1.1	Inventory list	10
5.1.2	Functions menu.....	11
5.1.3	Workspace	11
5.2	Main menu	11
5.2.1	RSCommander	11
5.2.2	File 12	
5.2.3	Functions.....	13
5.2.4	View	13
5.2.5	Window	14
5.2.6	Help.....	14
5.3	Functions.....	15
5.3.1	Add Instruments	15
5.3.2	Hardcopy	17
5.3.3	Trace Display	19
5.3.4	File Browser	23
5.3.5	Scripts	25
5.3.6	Interactive Control	41
5.3.7	Settings	43

1 Overview

RSCommander is a versatile software tool for a wide range of Rohde & Schwarz instruments. It makes it possible to take screenshots for documentation purposes, read trace data for further processing

The software also allows for file management and interactive control of the instrument using its remote control commands.

RSCommander automatically detects all supported Rohde & Schwarz instruments connected via GPIB, LAN and USB interfaces.

The following abbreviations are used in the following text for R&S® test equipment:

- ▶ R&S® is a registered trademark of Rohde & Schwarz GmbH und Co. KG.
- ▶ The R&S®FSV3000 Spectrum Analyzer is referred to as FSV.
- ▶ The R&S®FSW Signal and Spectrum Analyzer is referred to as FSW.
- ▶ The R&S®SMW200A Vector Signal Generator is referred to as SMW.
- ▶ The R&S®ZVA Vector Network Analyzer is referred to as ZVA.
- ▶ The R&S®ZVB Vector Network Analyzers is referred to as ZVB.
- ▶ The R&S®ZNB Vector Network Analyzer is referred to as ZNB.

2 Software

2.1 Features

RSCOMMANDER features the following:

- ▶ Automatic device detection via GPIB, LAN and USB interfaces
- ▶ "Look and feel" user interface of earlier RSCOMMANDER was kept to some degree
- ▶ Hardcopy of instrumentation screen
- ▶ Read trace data for up to six traces, depending on instrument
- ▶ File Manager for all of the instrument's internal file system
- ▶ Obtain instrument status information
- ▶ Interactive control using remote control commands

2.2 Requirements

RSCOMMANDER runs on a Windows 7/8/10 64-bit operating system and requires R&S® VISA to be installed. In case a GPIB interface is installed make sure that the correct driver has been installed prior to installing R&S® VISA. You can also install R&S®VISA if another VISA driver from a 3rd party manufacturer been installed previously. R&S®VISA has a managing tool for selecting a favorite VISA driver for each interface type.

RSCOMMANDER runs on macOS 10.7 and newer and can be installed via the App Store.

2.3 Installation

2.3.1 Windows

Execute the program *1MA074_RSCOMMANDER_X64_X.X.X.EXE* and follow the installation instructions.

2.3.2 macOS

Install via the App Store, by searching for "RSCOMMANDER" or "Rohde & Schwarz" or entering the following link in the browser: <https://itunes.apple.com/app/id1318630067>

3 Connecting the Instruments

RSCOMMANDER supports LAN, USB and GPIB instruments.

- ▶ **GPIB** instruments can be connected to the pc with the traditional daisy chain method.

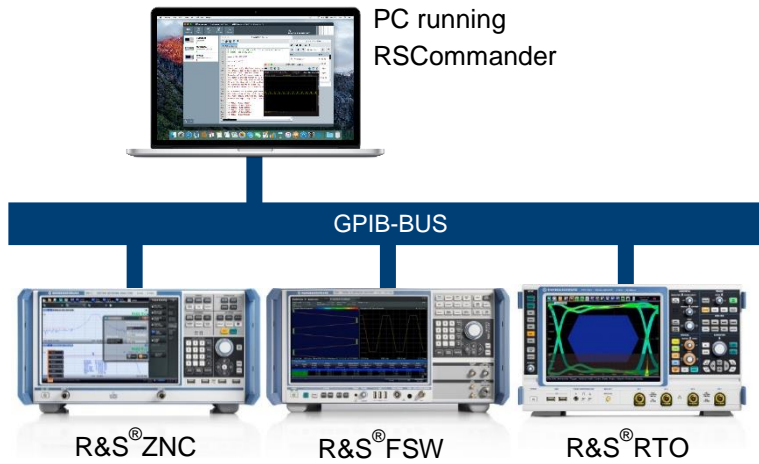

Figure 1: GPIB Instruments

- ▶ USB instruments have to be connected to the pc directly via USB cable.



Figure 2: USB instrument connected to PC

Note: USB VCP is not supported by RSCOMMANDER.

- ▶ LAN instruments may be connected to the pc either directly, allowing only one device per Ethernet port,



Figure 3: LAN instruments connected to PC

- ▶ or via Ethernet switch/hub, which is optionally connected to a DHCP server (company network)

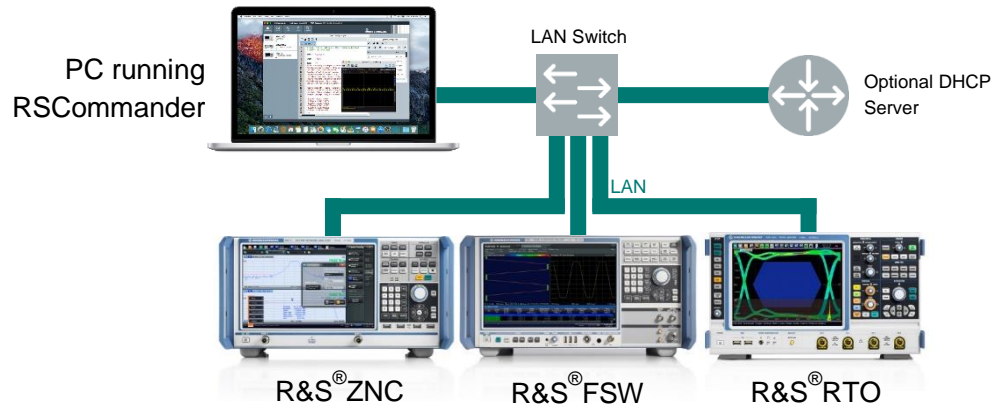

Figure 4: LAN instruments connected to switch

4 Getting Started

This example shows how to take a hardcopy from an FSV spectrum analyzer. The FSV is attached to the controller via Ethernet connection.

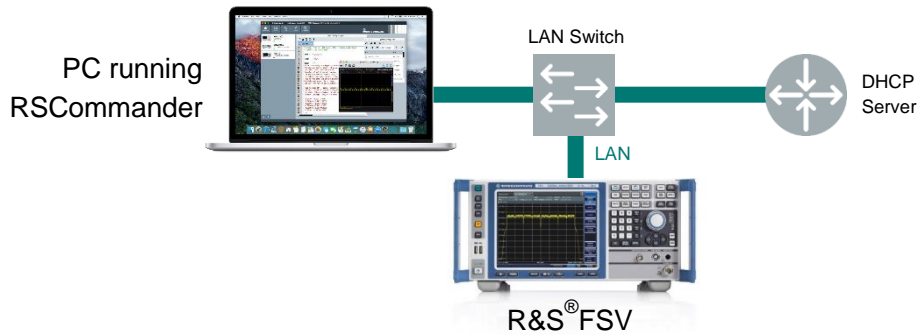

Figure 5: Example configuration

- ▶ Start **RSCOMMANDER**.
- ▶ Click on the **+** Button to add an instrument manually.

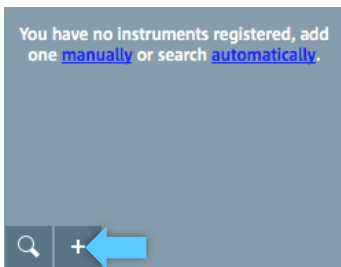

Figure 6: Inventory panel

- ▶ In the new Window, select an **interface** (1), enter a **connection address** (2) and press **Add** (3).

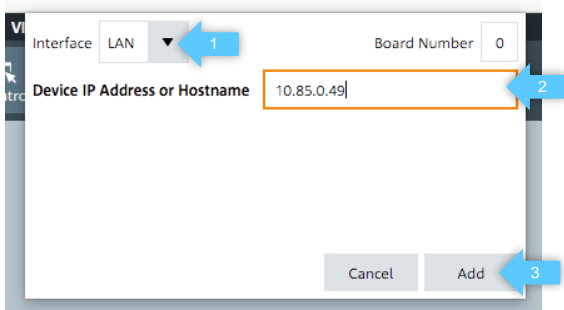
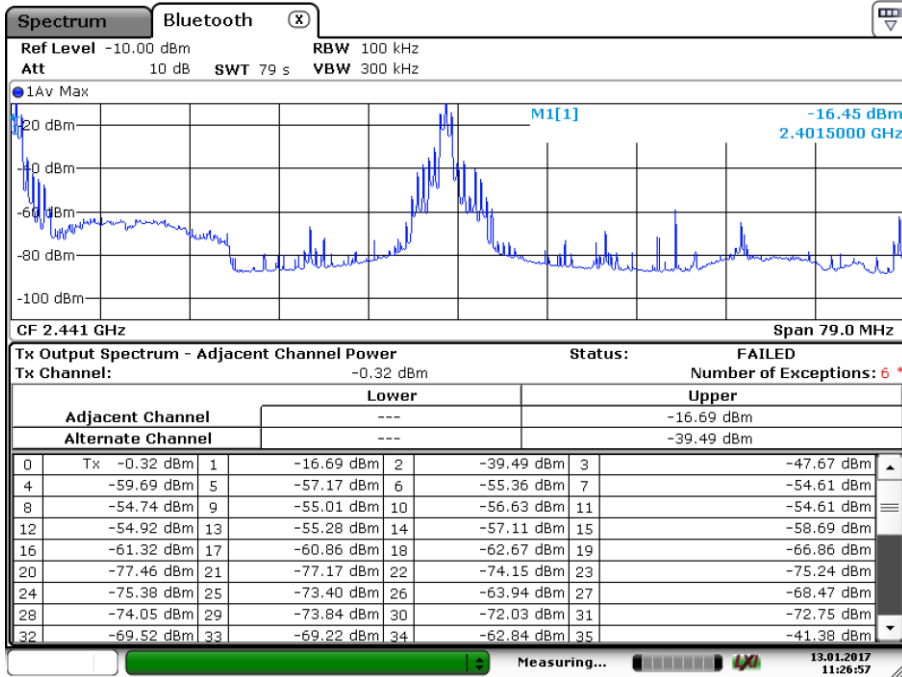

Figure 7: Adding instrument manually

Note: The Network Address can either be the full IPv4 address, e.g. 10.85.0.183, or the symbolic name, e.g. for the 30 GHz model of FSV with serial number 101794 the name **FSV30-101794**. If an external DNS-Server is in use, e.g. 8.8.8.8, only a connection via IP address is possible.

- ▶ The instrument is then automatically added to the **Inventory** list.

- Choose the FSV in the **Inventory** table and press the **Hardcopy** button.



Date: 13.JAN.2017 11:26:57

Figure 8: FSV hardcopy

5 Software Description

Click the **RSCCommander** icon to start the program. The main screen will appear after a few seconds.

5.1 Main screen

The main screen is separated in three different areas:

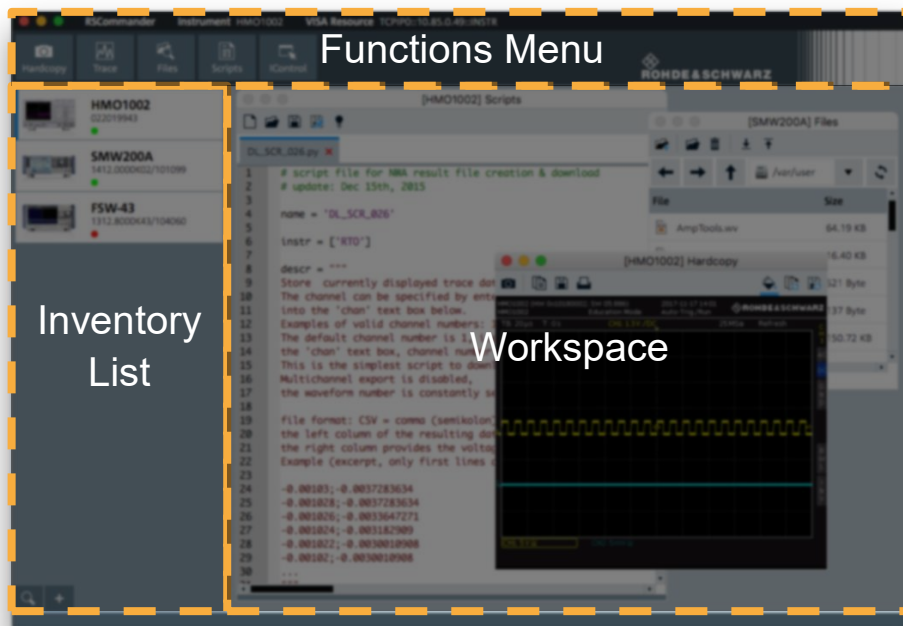

Figure 9: Main Screen

5.1.1 Inventory list

The Inventory section contains a list of the added devices and two buttons to add instruments automatically or manually.

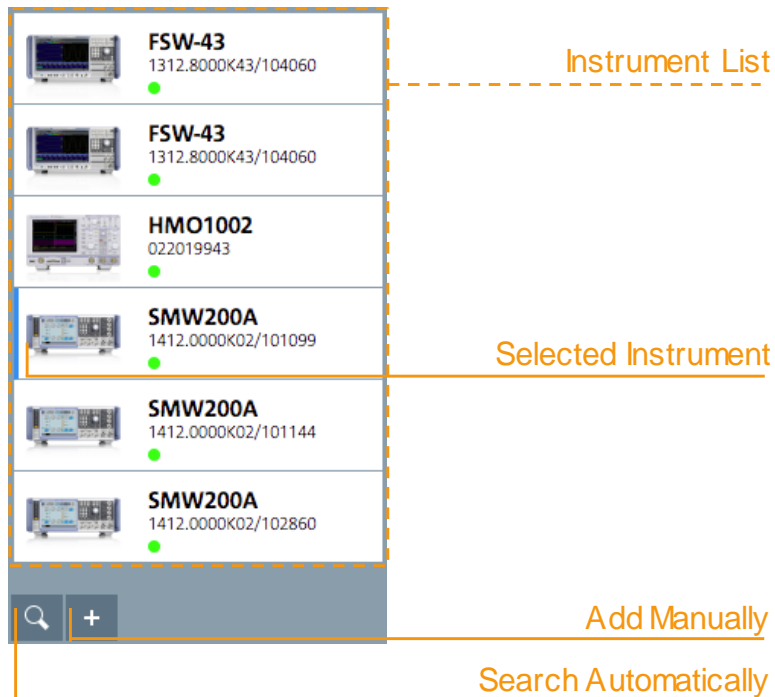

Figure 10: Description of the Inventory section

Each item in the list describes the device with the name, serial and a corresponding icon, like shown in Figure 11.

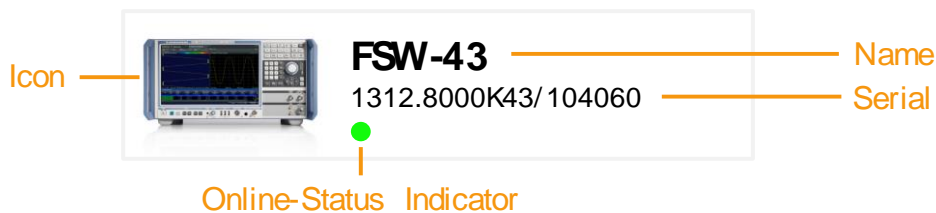

Figure 11: Instrument Item

The **Online-Status Indicator** shows the reachability of the Instrument and has three different states:

Status indicator States		
●	green	Device is reachable.
●	red	Device is unreachable.
○	gray cycle	Device status is unknown. Usually at application startup, if the program has not yet checked the status.

5.1.2 Functions menu

The Functions menu shows the name and the VISA resource of the current instrument and the functions that are available for this device. The individual functions are described in detail in chapter 5.3.

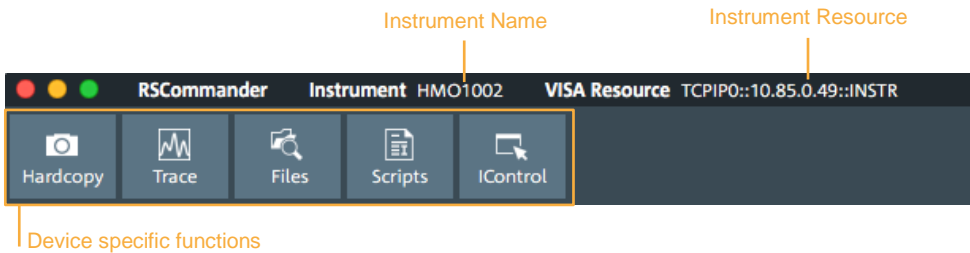

5.1.3 Workspace

The workspace area shows all open windows.

5.2 Main menu

The main menu appears as shown below and features six pull-down menus: **RSCOMMANDER**, **File**, **Functions**, **View**, **Window** and **Help**

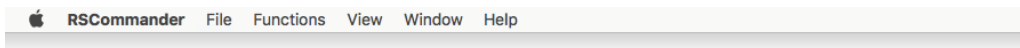

Figure 12: Main menu

5.2.1 RSCOMMANDER

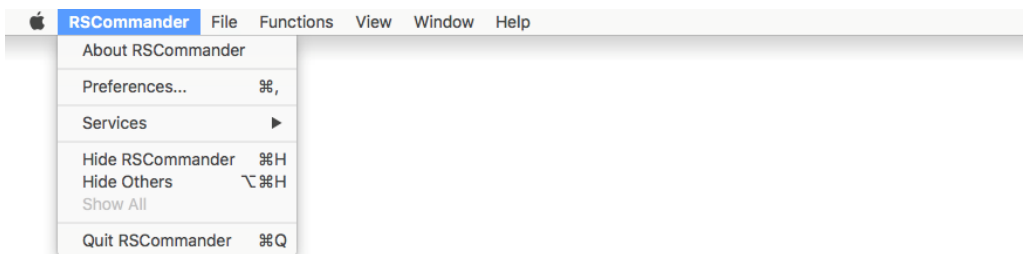

Figure 13: RSCOMMANDER Menu

About RSCommander

Displays information about the program version and installed drivers on the remote PC. This information can be copied to clipboard by pressing the button at the bottom of the System Information page.

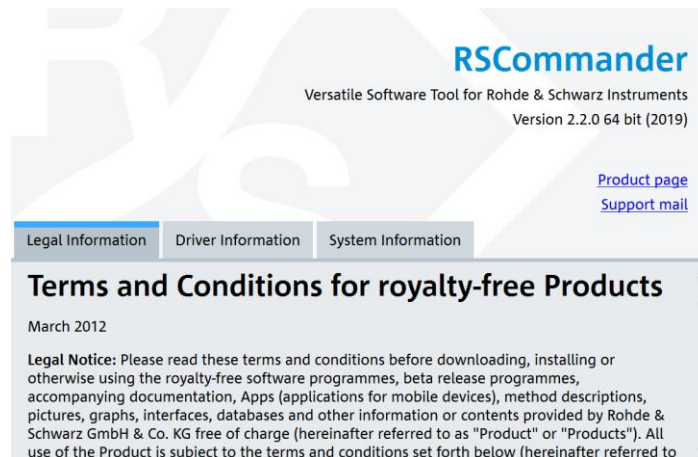

Figure 14: Information about RSCommander

Preferences...

⌘,

Opens the Settings window.
Described in detail in chapter 5.3.7.

Services

Menu for adding services to the application.
(Only available on macOS)

Hide RSCommander

⌘H

Hides the application.
(Only available on macOS)

Hide Others

⇧⌘H

Hides all windows but this.
(Only available on macOS)

Show All

Shows all hidden windows.
(Only available on macOS)

Quit RSCommander

⌘Q

Quits the application.

Note: This Menu is only available on macOS. On Windows About is located at the Help menu, Settings and Exit are at the File menu.

5.2.2 File

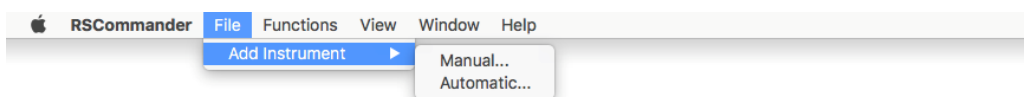

Figure 15: File Menu

Add Instrument ► Manual...

Opens a window to add an instrument manually.
Described in detail in chapter 5.3.1.1.

Add Instrument ► Automatic...

Searches for instruments.
Described in detail in chapter 5.3.1.2.

5.2.3 Functions

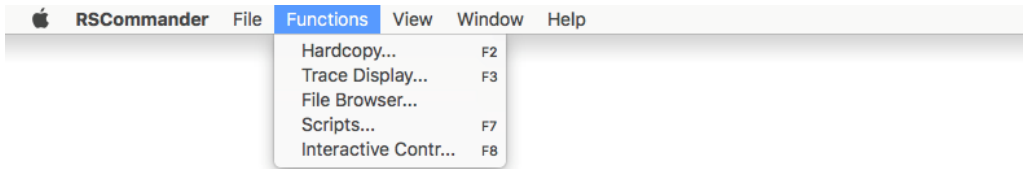

Figure 16: Functions Menu

Hardcopy... F2	Opens a Hardcopy window. Described in detail in chapter 5.3.2.
Trace Display... F3	Opens a Trace window. Described in detail in chapter 5.3.3.
File Browser...	Opens a Files window. Described in detail in chapter 5.3.4.
Scripts... F7	Opens a Scripts window. Described in detail in chapter 5.3.5.
Interactive Control... F8	Opens an Interactive Control window Described in detail in chapter 5.3.6.

5.2.4 View

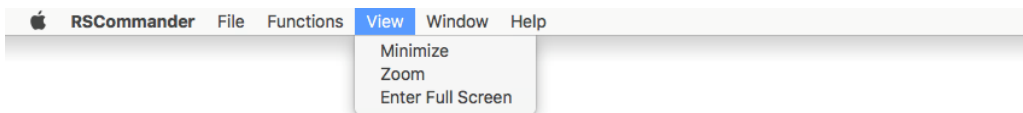

Figure 17: View Menu

Minimize	Minimizes the application.
Zoom	Maximizes the application.
Enter Full Screen	Goes to full screen. (Only available on macOS)

5.2.5 Window

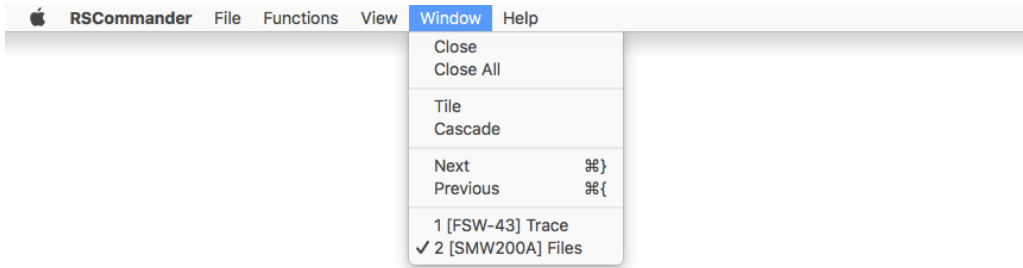

Figure 18: Window Menu

Close	Closes the current sub-window.
Close All	Closes all sub-windows.
Tile	Shows the sub-windows side by side.
Cascade	Cascades the sub-windows.
Next ⌘} / Ctrl+Tab	Moves the focus to the next sub-window.
Previous ⌘{ / Ctrl+Shift+Backtab	Moved the focus to the previous sub-window.

5.2.6 Help

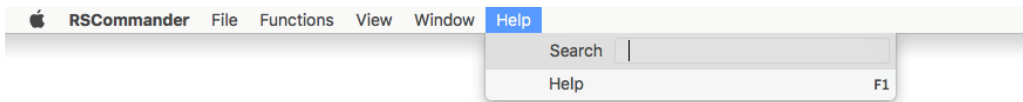

Figure 19: Help Menu

Search	Helps to find functions quickly. (Only available on macOS)
Homepage F1	Opens the website were this document is located.
Check for Updates...	Searches for an updated version of RSC Commander.

5.3 Functions

5.3.1 Add Instruments

There are two ways to add instruments to the inventory:

5.3.1.1 Manually

By clicking on **Add Manually** the window to add an instrument appears

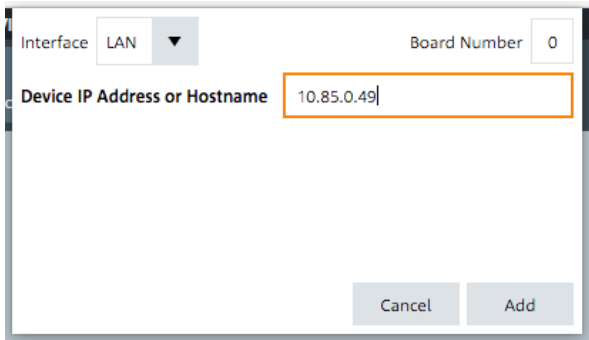

The screenshot shows a dialog box titled "Add Manually". At the top left, there is a dropdown menu labeled "Interface" with "LAN" selected. To the right, there is a "Board Number" input field containing the value "0". Below this, there is a larger input field labeled "Device IP Address or Hostname" containing the text "10.85.0.49". At the bottom right of the dialog, there are two buttons: "Cancel" and "Add".

Figure 20: Add Manually window

The window has tree views depending on which interface-type should be added. The **Interface** can be changed on the top left combo box.

The **Board Number** can be edited with the input field on the upper right. Usually this is "0", sometimes this have to be changed, e.g. if you are using GPIB1 this is "1".

For adding a device over **LAN**, enter the IP address or the computer name (1) and click the **Add** (2) button.

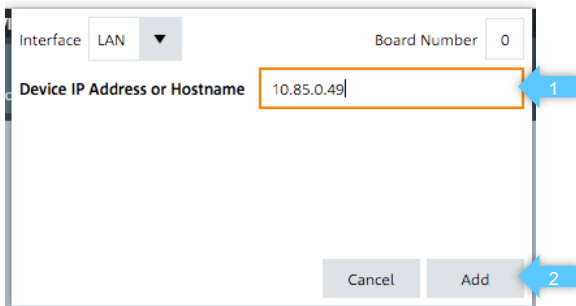

This screenshot is identical to Figure 20 but includes two blue callout boxes with arrows. Callout "1" points to the "Device IP Address or Hostname" input field. Callout "2" points to the "Add" button.

For adding a device over **GPIB**, choose GPIB (1), enter the address (2) and click the **Add** (3) button.

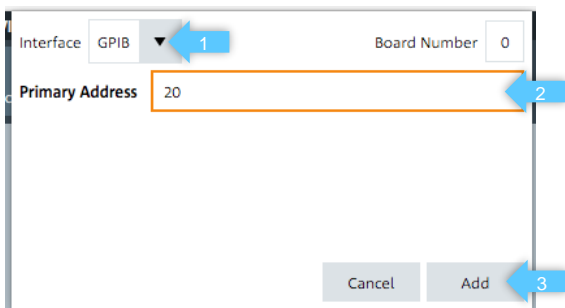

The screenshot shows the dialog box with the "Interface" dropdown menu set to "GPIB". The "Board Number" field still contains "0". The input field is now labeled "Primary Address" and contains the value "20". At the bottom right, the "Add" button is highlighted with a blue callout box labeled "3". A blue callout box labeled "1" points to the "Interface" dropdown menu, and another blue callout box labeled "2" points to the "Primary Address" input field.

For adding a device over **USB**, choose USB (1), enter the vendor id (2), product id (3), serial (4) and click the **Add** (5) button.

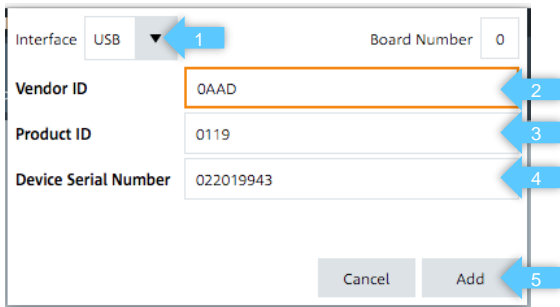

Afterwards RSC Commander tries to establish a connection to the device; if this is successful, it will be added.

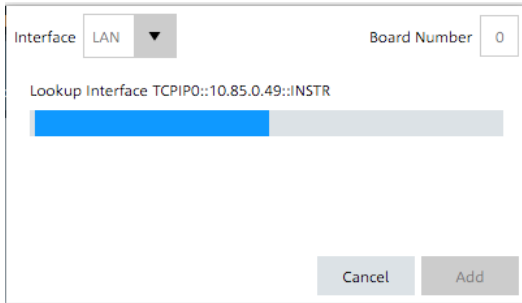

Note: RSC Commander finds out what kind of instrument it is by checking the identification string (*IDN?) when it is edited on the device, the instrument cannot be added.

5.3.1.2 Automatically

Click on Search to start the search process. The following window appears and disappears when the search is over.

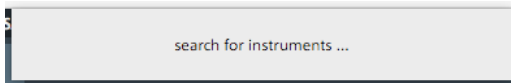

Figure 21: Search Window

The devices were automatically added to the inventory.

5.3.2 Hardcopy

Takes a screenshot of the selected instrument screen and copies the image to the selected destination.

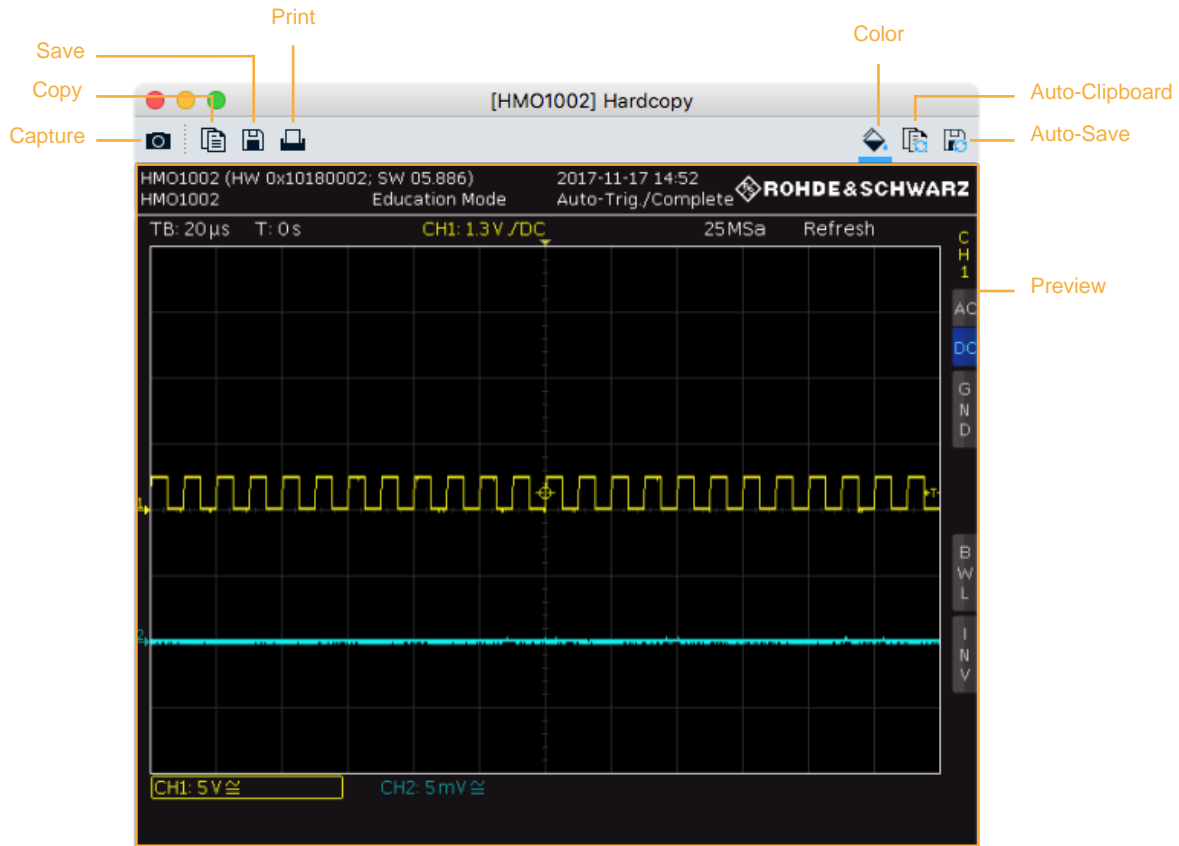

Figure 22: Hardcopy Window

The following functions are available in the hardcopy window:

- Capture** Takes a new screenshot and updates the current window.
F5
- Copy** Copies the screenshot to the clipboard, from where it can be pasted into other applications with ⌘V (Windows: Ctrl+V).
⌘C / Ctrl+C
- Save** Opens a file dialog for saving the image file.
⌘S / Ctrl+S
- Print** Opens a dialog for printing the screenshot.
⌘P / Ctrl+P
- Color** Enable/Disable colored screenshots. This will only work on devices that support colored screenshots.
- Auto-Clipboard** This copies the image into the clipboard on every capture. It can be pasted with ⌘V (Windows: Ctrl+V).
- Auto-Save** Automatically save the screenshot image to a file named:
<Default Directory>\<name of the instrument>@yyyy-mm-dd_hr_min_sec.<ext>

Note: Cause of the sandbox restrictions on macOS this function is only available on Windows.

Note: The screenshots of R&S®ZVK, R&S®ZVM and R&S®ZVC network analyzers cannot be displayed with the internal picture viewer. RSCommander uses Microsoft Windows / macOS default picture viewer in this case.

5.3.3 Trace Display

Performs a trace on the selected instrument and returns the data to the selected destination. The data is displayed in a customized graphic.

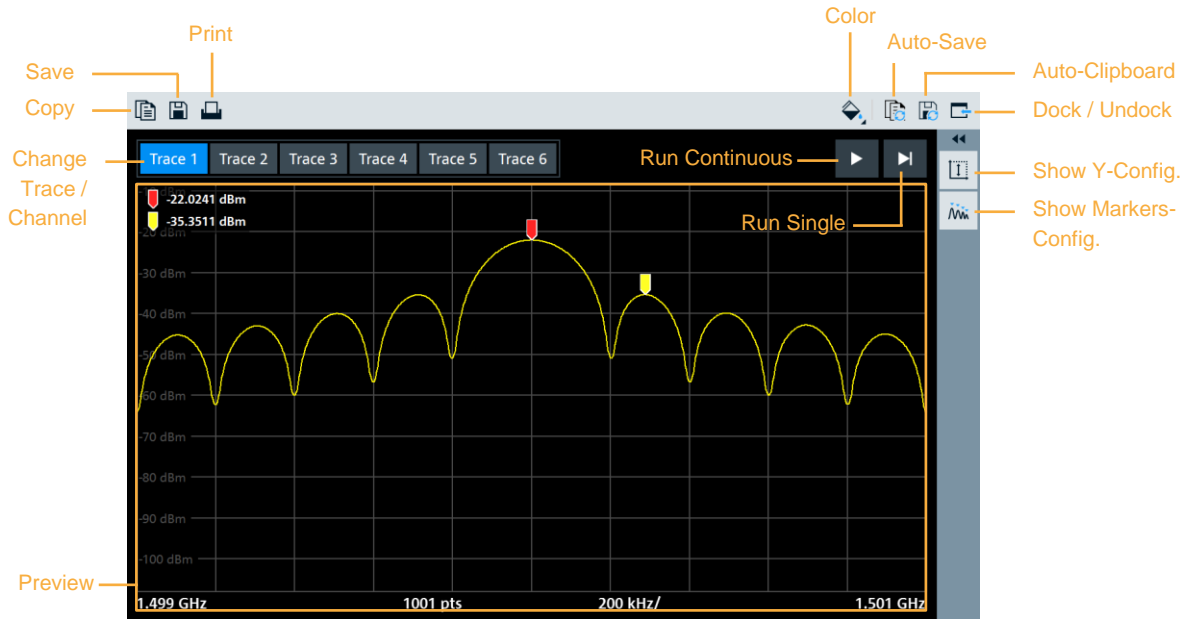

Figure 23: Trace Window

The following functions are available in the trace window:

Copy

⌘C / Ctrl+C

Copies the trace data to the clipboard, from where it can be pasted into other applications with ⌘V (Windows: Ctrl+V), e.g.:

```
987250000; -97.6549911499023
987290865.384615; -101.38890838623
987331730.769231; -100.270118713379
987372596.153846; -101.440811157227
987413461.538462; -99.4232406616211
987454326.923077; -98.0625915527344
987495192.307692; -97.9781723022461
987536057.692308; -98.2845458984375
987576923.076923; -99.3772201538086
987617788.461538; -98.2349472045898
```

Save

⌘S / Ctrl+S

Opens a dialog box to specify a file name and save the current trace data.

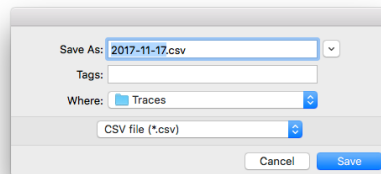

Print

⌘P / Ctrl+P

Opens a dialog for printing the trace graphic.

Color

Opens a dialog for changing the color of the trace graphic, e.g.:

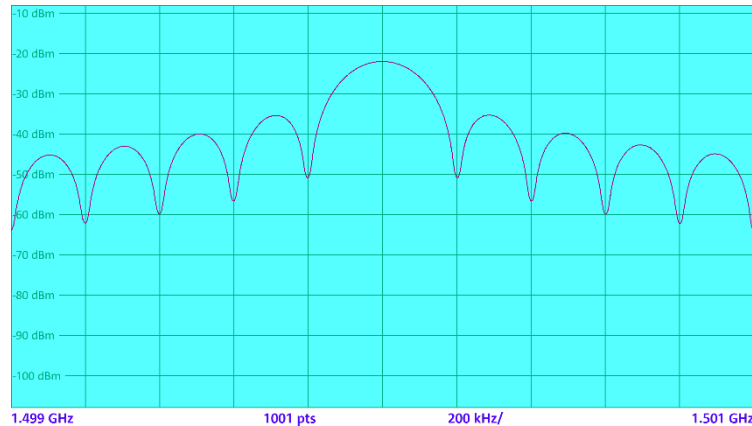

Auto-Clipboard

Copies the graph of the trace data to the clipboard on update. It can be imported to any document with ⌘V (Windows: Ctrl+V).

Auto-Save

Save the trace data (level vs. frequency or level vs. time) to the file

`<Default Directory>\<name of the instrument>@yyyy-mm-dd_hr_min_sec.csv`

Note: Cause of the sandbox restrictions on macOS this function is only available on Windows.

Dock / Undock

Docks or undocks the window from the workspace.

Change Trace / Channel

Selects the according trace / channel. An additional trace must be defined on the device manually (see instrument manual for details).

Run Continuous

Reads the trace data continuously in a loop. (**Auto-Clipboard** and **Auto-Save** are disabled in this mode)

Run Single

Reads the data of the trace number and updates the current window.

Show Y-Config

Shows / Hides the **Y-Configuration Panel**

Show Markers-Config

Shows / Hides the **Markers Panel**

5.3.3.1 Y-Configuration

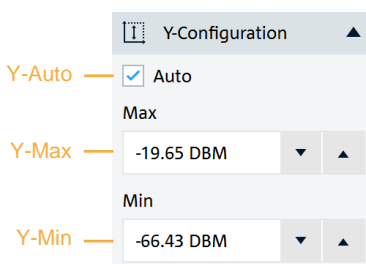
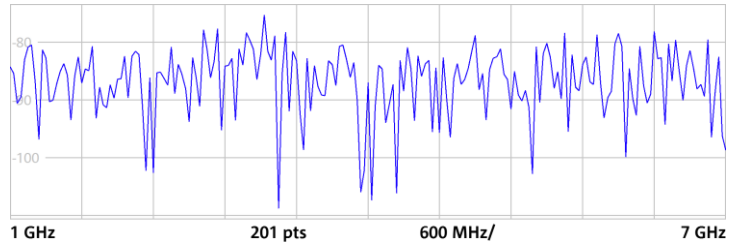

Figure 24: Y-Configuration Panel

Note: This is not available for smith or polar charts

Y-Auto

Adjusts the vertical maxima of the graphic automatically, e.g.:



Y-Max Defines the upper bound of the graphic.
Y-Min Defines the lower bound of the graphic.

5.3.3.2 Markers

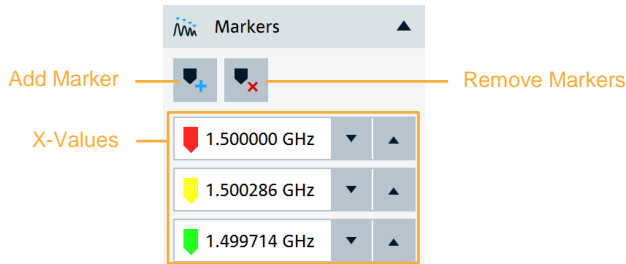
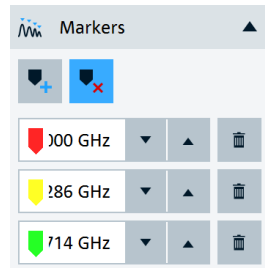

Figure 25: Markers Panel

Note: This is not available for smith or polar charts

Add Marker Adds a new marker to the trace. The marker will be placed to the highest peak where no marker is already placed. A maximum of six markers can be placed.

Remove Markers Jumps to a mode in which individual markers can be removed:



X-Values The x-values of the individual markers can be changed.

5.3.3.3 Preview

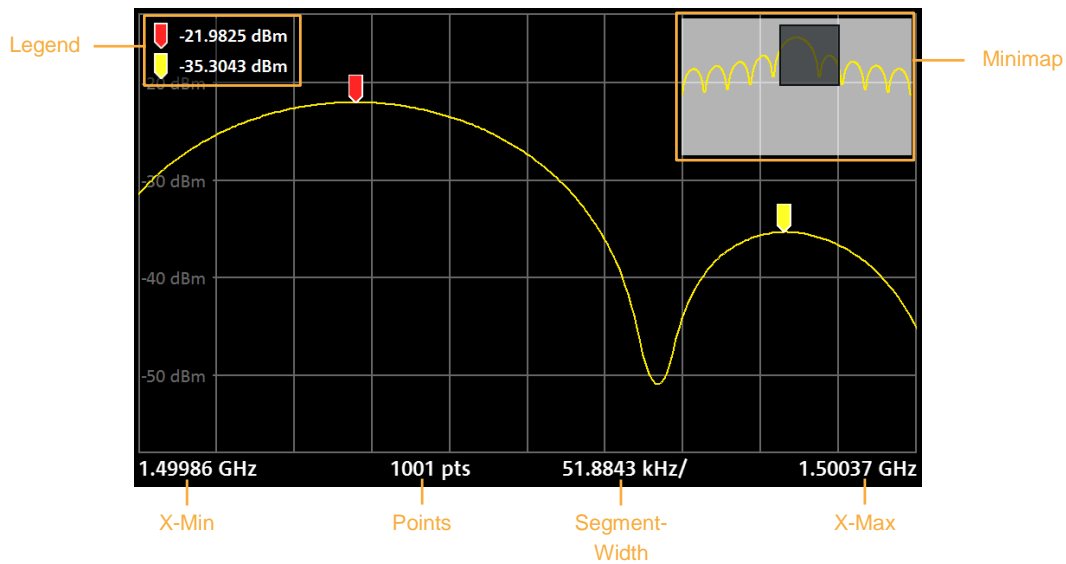

Figure 26: Preview

- Legend** Displays the y-values of the markers.
- Minimap** Shows where the current section is in the entire trace when the trace is zoomed in.
- X-Min** The left bound of the trace or the section.
- X-Max** The right bound of the trace or the section.
- Points** The number of measurement points of the trace
- Segment-Width** The width of a single segment (the distance between two vertical lines).

The preview can be interacted with in different ways: the vertical position can be changed with a mouse click, as well as it can be zoomed into the trace. In addition, the markers can be easily moved.

To change the vertical position, move the axis up or down in the middle with the mouse button pressed down. The following symbol will be shown:



To change y-max and y-min the upper and lower third must be dragged analogously.

Either to zoom into the display you can drag a rectangle with the mouse to the desired area or in the case of a touch screen you can also zoom in by pinching:

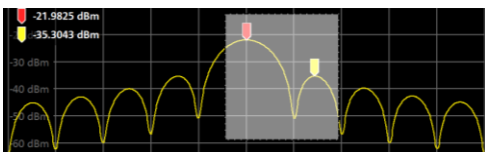

In order to move the markers it is enough to drag them to the desired position.

5.3.4 File Browser

Allows you to copy files from the instrument to the PC or vice versa. This function is useful especially for GPIB instruments. A more effective way to access files on LAN instruments is either via net drive or remote desktop.

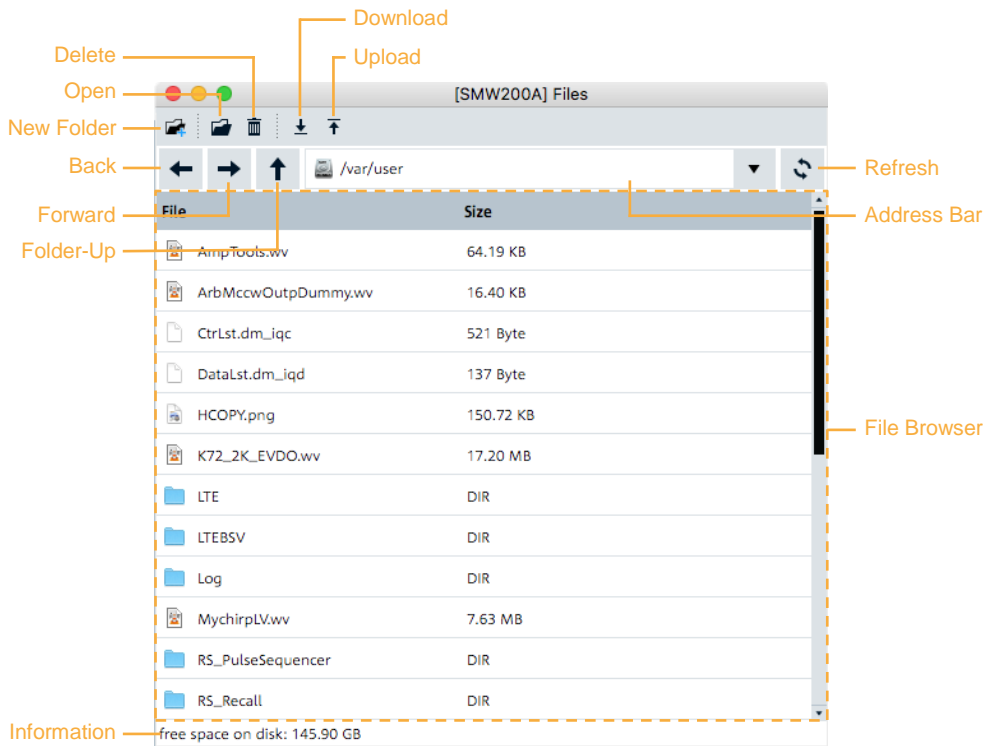

Figure 27: Files Window

The following functions are available in the trace window:

- New Folder** Creates a new folder in the current directory with a specific name.
- Open** Opens a file or navigates to a folder.
⌘O / Ctrl+O
- Delete** Deletes a file or a directory.
⌘ / Del
Attention: This function does not move the file to trash. The file cannot be restored!
- Download** Loads a file from the instrument.
- Upload** Loads a file to the instrument.
- Back** Navigates to the previous directory.
- Forward** Navigates to the next directory.
- Folder-Up** Navigates to the parent folder.
- Refresh** Reloads the list of files / folders in the current directory.

5.3.4.1 Context Menu

With clicking on a file or folder the context menu opens:

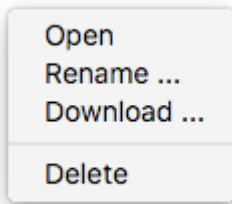

Note: Open, Rename and Download only works with files.

5.3.4.2 Drag & Drop

A file can be loaded to the instrument with drag & drop from the Finder or Windows Explorer.

5.3.4.3 Alternative Use

The file browser function can also be used for displaying and copying screenshots performed on the instrument itself. The following example shows how to display or copy a screenshot file located on the CMU.

Note: When using a CMU instrument, RSCommander can only transfer and view hardcopies, which have previously been initiated manually by pressing the PRINT key on the frontpanel of the instrument.

- ▶ **Open Files.**
- ▶ Go to the **INT** subdirectory.
- ▶ Double-click on the preferred file to either **Open** with the default windows viewer or transfer and **Download** to the local hard drive.

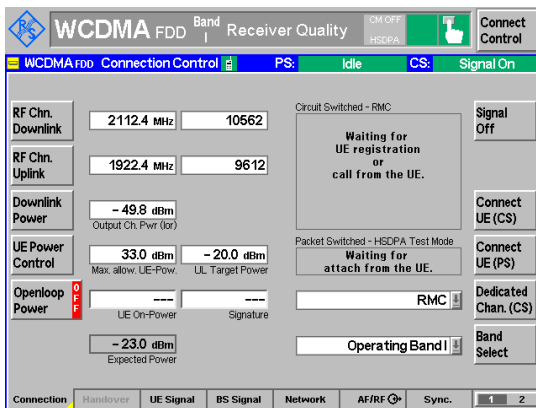

Figure 28: CMU Hardcopy

5.3.5 Scripts

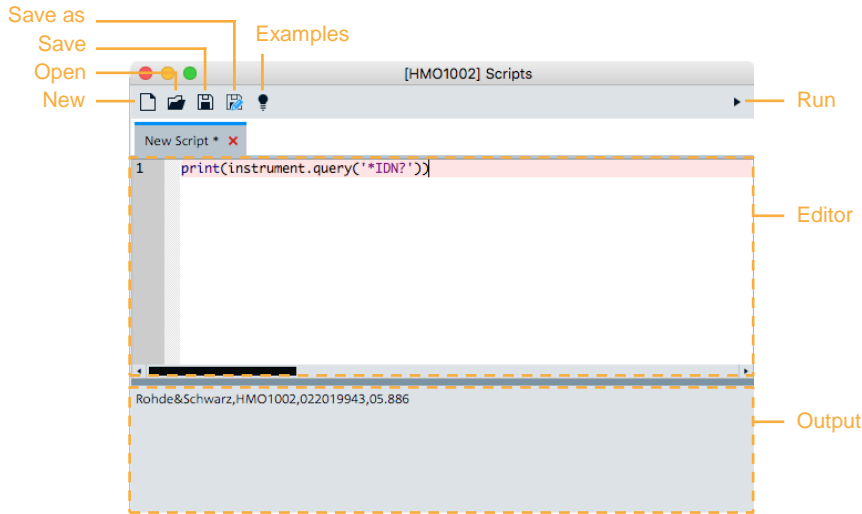

Figure 29: Scripts window

The following functions are available in the trace window:

New	Creates and opens a new script.
Open ⌘O / Ctrl+O	Opens an existing script.
Save ⌘S / Ctrl+S	Saves the current file, if the script is new it works like Save as.
Save as	Saves the current file to a specific directory.
Examples	Opens a Dialog where example scripts could be chosen.
Run	Executes the current script.

5.3.5.1 Writing custom Scripts

RSCOMMANDER uses the programming language Python to interpret scripts. The pyvisa library is used to control the instruments.

The current device is already initialized with the following snippet:

```
import visa
resource_manager = visa.ResourceManager()
instrument = resource_manager.open_resource('<visa_resource>')
```

A device can be controlled with the following three elementary commands:

- ▶ `instrument.write()` : Sends data to the device
- ▶ `instrument.read()` : Reads data from device
- ▶ `instrument.query()` : Writes data to the device and reads the response

For more commands, please refer to the PyVISA documentation under <https://pyvisa.readthedocs.io>.

Note:

The script function in RSCommander is best suited for controlling only one device. To control several devices at the same time and perform complex measurements please use R&S®Forum¹.

5.3.5.1.1 Hello World Example

These quick steps explain how to program a simple idn query:

1. Open a new Script by pressing **New**
2. Enter the following line in the text input:

```
response = instrument.query('*IDN?')  
print 'Hello, I am ' + response
```

3. Click **Run**
4. A similar return as this one should appear:

```
Hello, I am Rohde&Schwarz,RTB2004,1333.1005k04/101457,01.902
```

5.3.5.2 Use predefined Examples to download Trace Data of Vector Network Analyzers

The following examples have been provided to download result files from vector network analyzers (VNA). Users may create scripts for their own instruments. Similar to the general **Files** command button, data transfer can be performed from the VNA to a local PC via the remote control interface. In contrast to the **Files** button the data transfer function on behind the **Scripts** button does not expect any file already available on the VNA, but automatically creates the file to be downloaded, for instance s-parameter result files. The properties of the file to be created are specified via so called **Script** files which include all information the VNA needs in order to create a special file format. The user simply has to select a special format by selecting an appropriate script file. For ZNB and ZVAB there are ten prepared basic script files available each, according to the ten most common file formats.

Depending on the selected script file, the user sometimes has to edit a channel number or a trace name. The user can finally specify the file name, which is used to store the result file on the local PC. Simply pressing the **Run** button at the user interface of RSCommander will perform file creation on the VNA and will automatically transfer the result file to the local PC. All this is done on a completely remote controlled way; there is no need to operate the VNA manually for this purpose.

This way VNA result files of *.s1p, *.s2p or *.CSV formats with various options can be easily created and downloaded to a local PC in order to be post-processed or being displayed by means of various user application software.

For trace data download the **Trace** button is not usable for all VNA families. The **Script** button instead provides sophisticated and convenient replacement for the **Trace** button.

The subsequent text provides detailed information how to perform file downloads, a summary of the predefined script files, a description of a sample session and a set of frequently asked questions.

5.3.5.2.1 File Creation and Download

Explanation of the **Scripts** user interface and proceeding for file transfer:

¹ R&S®Forum can be downloaded at <https://www.rohde-schwarz.com/appnote/1MA196>.

1. Open the list of example script by pressing the bulb icon on the top.

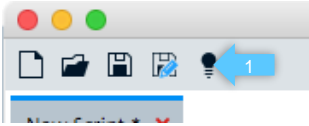

2. Select a script file from list and click open.

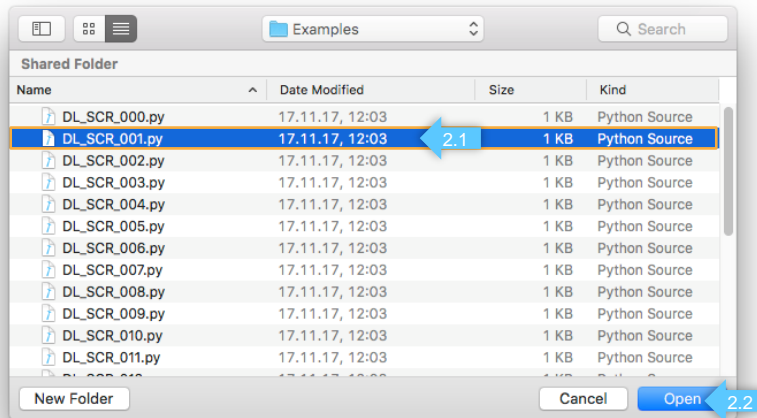

3. Analyse the script to see if it matches your application. What the script can do is described in it.

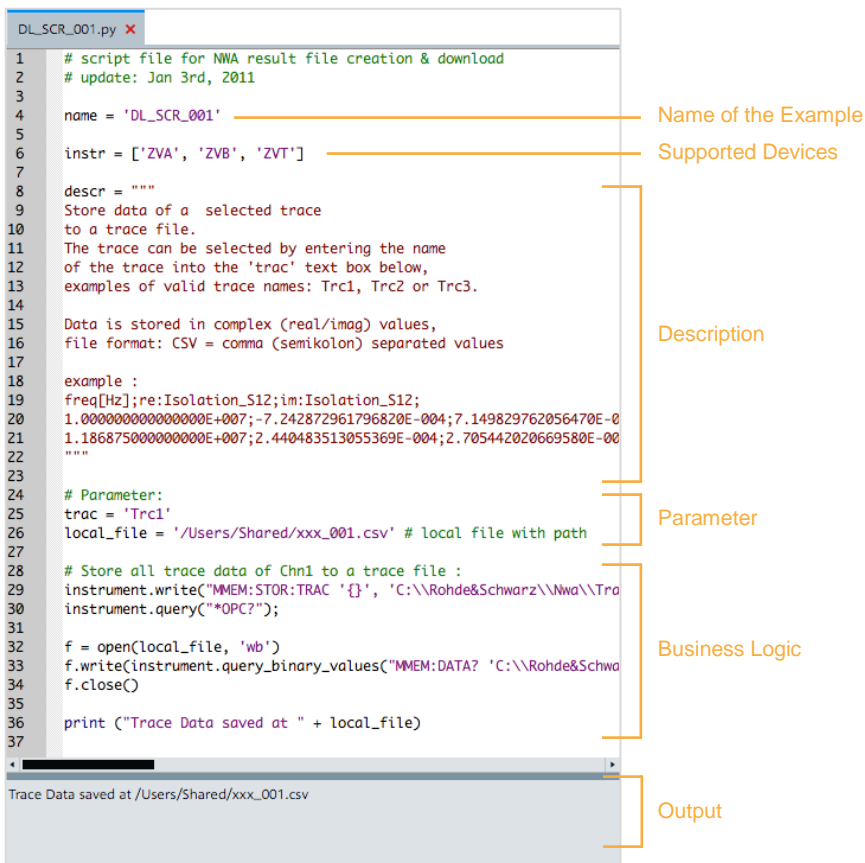

4. Edit the parameters for your purpose.

In the example above, the line, starting with *local_file* specifies the target location where the file will be stored on the local PC and the variable *trac* defines which trace should be stored.

5. Execute the script by clicking the **Run** button above.

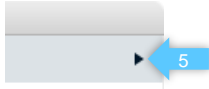

6. The output field finally shows whether the operation was successful or if a problem has been encountered.

Script Files for VNA Family R&S®ZNB

For R&S®ZNB there are currently ten script files available according to the ten most common file formats. The script with the name “DL_SCR_016” is the simplest one. It stores all traces from channel 1 of the VNA to the local file on the PC. A common CSV (comma separated values) file format with real/imag values and semicolon as field separator is used in this case.

Using script file “DL_SCR_017” a special trace can be selected by its name for file creation and download. Using script file “DL_SCR_018” a special channel can be selected by its number, all traces belonging to this channel are taken into account in this case.

Each of the ten basic script files provides detailed information on its properties displayed in the *desc* variable inside the script.

The table below summarizes the 10 examples provided for R&S®ZNB:

Name	Purpose	Channel	Trace	Data format	CSV	SxP	Field Sep
DL_SCR_016	Simple format, real / imag	Always 1	All traces from Ch1	Real/ Imag	X	-	;
DL_SCR_017	Selectable trace, real / imag	-	Specified by name	Real/ Imag	X	-	;
DL_SCR_018	Selectable channel, real / imag	Specified by number	All traces from sel. Channel	Real/ Imag	X	-	;
DL_SCR_019	Simple format, dB magn.	Always 1	All traces from Ch1	dB magn.	X	-	;
DL_SCR_020	Selectable trace, dB magn	-	Specified by name	dB magn.	X	-	;
DL_SCR_021	Selectable channel, dB magn	Specified by number	All traces from sel. Channel	dB magn.	X	-	;
DL_SCR_022	Selectable trace, S1P	-	Specified by name	Real/ Imag	-	S1P	Alike SxP std.
DL_SCR_023	Selectable trace, S1P	-	Specified by name	Lin. magn. & phase	-	S1P	Alike SxP std.
DL_SCR_024	Selectable trace, S1P	-	Specified by name	dB magn. & phase	-	S1P	Alike SxP std.
DL_SCR_025	Selectable channel, S2P	Specified by number	All traces from sel. Channel	Accord. to SxP std.	-	S2P	Alike SxP std.

Example: In an actual test setup the R&S®ZNB displays three traces in three channels. All traces are known by their name and the data of just one single trace is to be downloaded. The data format is expected to be in logarithmic magnitude in dB. In this case script file “DL_SCR_020” has to be selected, because the selection of a special trace by its name is possible in this case. For multipoint tests using script “DL_SCR_025” all measurement results must be available for successful download. Two port tests for instance need the results of S11, S22, S12 and S21 parameters before pressing the **Run** button in the scripts window, i.e. starting the download function.

If the R&S®ZNB displays only a single trace either the script “DL_SCR_016” or “DL_SCR_019” are recommended, depending on the expected data format “real/imaginary” or “dB magnitude” respectively.

In order to explore the behaviour of the script files it is recommended to select one after each other and press **Run**. Due to the unique default *local_file* name we will get ten different result files in the target directory which can be compared with the VNA display one after each other. This way it is easy to get an idea about the output format created by each script file. The marker function along with its info field is suitable to compare the trace values with the data in the downloaded file.

The set of supported data formats within RSCCommander can be easily extended by additional script files.

The example scripts are installed along with the installation of RSCommander. Therefore, the scripts are automatically updated with each update of RSCommander.

5.3.5.2.2 Script Files for VNA Families R&S®ZVA / R&S®ZVB

For R&S®ZVAB ZVA and R&S®ZVB there are currently ten script files available according to the ten most common file formats. The script with the name “DL_SCR_000” is the simplest one. It stores all traces from channel 1 of the VNA to the local file on the PC. A common CSV (comma separated values) file format with real/imag values and semicolon as field separator is used in this case.

Using script file “DL_SCR_001” a special trace may be selected by its name for file creation and download. Using script file “DL_SCR_002” a special channel may be selected by its number, all traces belonging to this channel are taken into account in this case.

Each of the ten basic script files provides detailed information on its properties displayed in the *desc* variable inside the script.

The table below summarizes the 10 script files for R&S®ZVAB:

Name	Purpose	Channel	Trace	Data format	CSV	SxP	Field Sep
DL_SCR_000	Simple format, real / imag	Always 1	All traces from Ch1	Real/ Imag	X	-	;
DL_SCR_001	Selectable trace, real / imag	-	Specified by name	Real/ Imag	X	-	;
DL_SCR_002	Selectable channel, real / imag	Specified by number	All traces from sel. Channel	Real/ Imag	X	-	;
DL_SCR_003	Simple format, dB magn.	Always 1	All traces from Ch1	dB magn.	X	-	;
DL_SCR_004	Selectable trace, dB magn	-	Specified by name	dB magn.	X	-	;
DL_SCR_005	Selectable channel, dB magn	Specified by number	All traces from sel. Channel	dB magn.	X	-	;
DL_SCR_006	Selectable trace, S1P	-	Specified by name	Real/ Imag	-	S1P	Alike SxP std.
DL_SCR_007	Selectable trace, S1P	-	Specified by name	Lin. magn. & phase	-	S1P	Alike SxP std.
DL_SCR_008	Selectable trace, S1P	-	Specified by name	dB magn. & phase	-	S1P	Alike SxP std.
DL_SCR_009	Selectable channel, S2P	Specified by number	All traces from sel. Channel	Accord. to SxP std.	-	S2P	Alike SxP std.

Example: In an actual test setup the ZVA displays three traces in three channels. All traces are known by their name and the data of just one single trace is to be downloaded. The data format is expected to be in

logarithmic magnitude in dB. In this case script file “DL_SCR_004” has to be selected, because the selection of a special trace by its name is possible in this case.

If the R&S®ZVA displays only a single trace the script “DL_SCR_000” or “DL_SCR_003” are recommended, depending on either the expected data format “real/imaginary” or “dB magnitude” respectively.

There exist further script files for other instruments beyond R&S®ZNB, R&S®ZVA and R&S®ZVB; however, they behave in a similar way and are herein not described.

5.3.5.2.3 Sample Session

Provided the network analyzer R&S®ZVA shows results as depicted in the figure below:

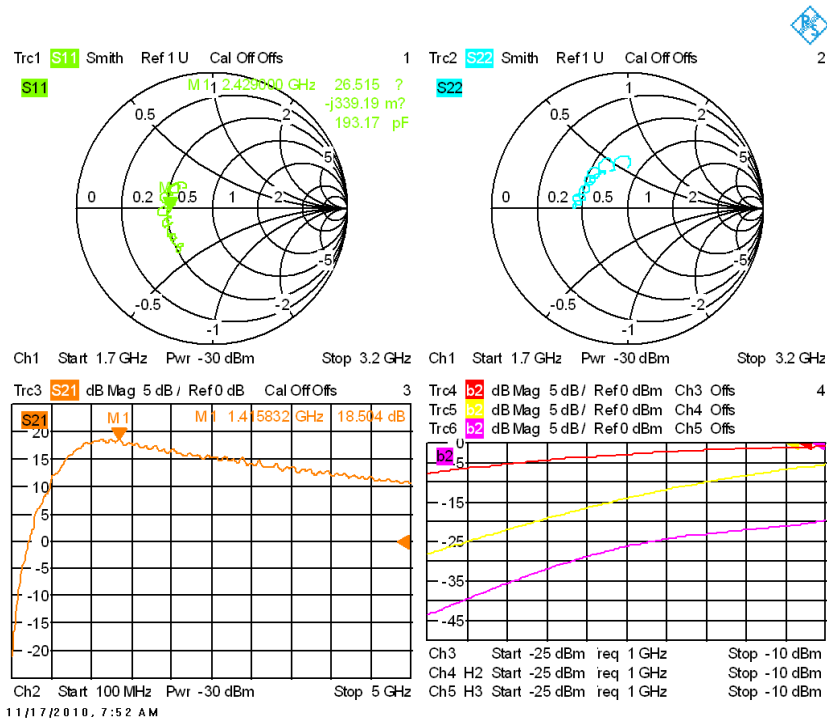

There are 6 traces scattered over 5 channels. Channel 1 includes 2 traces. Each trace is shown in an individual Smith chart in the upper half of the figure. The window in the lower left includes one single trace Trc3 within the channel Ch2. The window in the lower right includes 3 traces (Trc4, Trc5 and Trc6) distributed over 3 channels (Ch3, Ch4 and Ch5).

In the following three examples we will show how to download specific parts of various R&S®ZVA traces as shown in this screen shot.

5.3.5.2.3.1 Example 1: Download all traces from Channel 1

In this case we will download S11 data from the green trace in the upper left and S22 data from the blue trace in the upper right. We can use the simplest script file from the script file selection list as shown in the code below:

```
# script file for NWA result file creation & download
# update: Jan 3rd, 2011

name = 'DL_SCR_000'

instr = ['ZVA', 'ZVB', 'ZVT']

descr = ""
Store a l l trace data of channel 1 to a trace file.
This is the simplest form, but neither trace nor
channel can be selected.

If you want to select a special trace,
then use DL_SCR_001

If you want to select a special channel,
then use DL_SCR_002

Data is stored in complex (real/imag) values,
file format: CSV = comma (semikolon) separated values

example (Excerpt, first columns only) :
freq[Hz];re:Gain_S21;im:Gain_S21;re:Isolation_S12;im:Isolation_S12;
1.0000000000000000E+007;8.440270903520286E-004;-2.370694164710585E-
005;-7.242872961796820E-004;
1.1868750000000000E+007;-1.491044531576335E-004;4.370445458334871E-
005;2.440483513055369E-004;
""

# Parameter:
local_file = '/Users/Shared/S11_22_result.csv' # local file with
path

# Store all trace data of Chn1 to a trace file :
instrument.write("MMEM:STOR:TRAC:CHAN 1,
'C:\\Rohde&Schwarz\\Nwa\\Traces\\lcpy_000.csv'")
instrument.query("*OPC?");

f = open(local_file, 'wb')
f.write(instrument.query_binary_values("MMEM:DATA?
'C:\\Rohde&Schwarz\\Nwa\\Traces\\lcpy_000.csv'", datatype='B',
is_big_endian=False, container=bytearray))
f.close()

print ("Trace Data saved at " + local_file)
```

We define the target path to “/Users/Shared” and the target file name to “S11_22_result.csv”. This is done by editing the *local_file* variable.

After pressing the **Run**-button, we will get the result file as listed in the excerpt below:

```

# Version 1.00
#
freq[Hz];re:Trc1_s11;im:Trc1_s11;re:Trc2_s22;im:Trc2_s22;
1.7000000000000000E+009;-2.639982007647828E-001;-2.477388349698523E-001;-3.774877060209435E-001;2.324034080768671E-002;
1.703006012024048E+009;-2.617725862064601E-001;-2.494733964388582E-001;-3.759027275370633E-001;1.990155780128078E-002;
1.706012024048096E+009;-2.609186292182608E-001;-2.51427873332056E-001;-3.755329507400619E-001;1.957187428872192E-002;
1.709018036072144E+009;-2.60156390995092E-001;-2.530377381670864E-001;-3.751942568904543E-001;1.680042136060319E-002;
1.712034468065107E+009;-2.594232010306541E-001;-2.552101113645545E-001;-3.74764463908003E-001;1.47460095130733E-002;

```

Both traces of channel 1 are included.

5.3.5.2.3.2 Example 2: Download the single trace “Trc2” (upper right curve of VNA display)

In this case, we will use script “DL_SCR_001” as shown below

```

# script file for NWA result file creation & download
# update: Jan 3rd, 2011

name = 'DL_SCR_001'

instr = ['ZVA', 'ZVB', 'ZVT']

descr = ""
Store data of a selected trace
to a trace file.
The trace can be selected by entering the name
of the trace into the 'trac' text box below,
examples of valid trace names: Trc1, Trc2 or Trc3.

Data is stored in complex (real/imag) values,
file format: CSV = comma (semikolon) separated values

example :
freq[Hz];re:Isolation_S12;im:Isolation_S12;
1.0000000000000000E+007;-7.242872961796820E-
004;7.149829762056470E-004;
1.1868750000000000E+007;2.440483513055369E-
004;2.705442020669580E-004;
""

# Parameter:
trac = 'Trc2'
local_file = '/Users/Shared/S22.csv' # local file with path

# Store all trace data of Chn1 to a trace file :
instrument.write("MMEM:STOR:TRAC '{}',
'C:\\Rohde&Schwarz\\Nwa\\Traces\\lcpy_001.csv'".format(trac))
instrument.query("*OPC?");

f = open(local_file, 'wb')
f.write(instrument.query_binary_values("MMEM:DATA?
'C:\\Rohde&Schwarz\\Nwa\\Traces\\lcpy_001.csv'", datatype='B',
is_big_endian=False, container=bytearray))
f.close()

print ("Trace Data saved at " + local_file)

```

As we can see, this script is expecting a trace name. We have entered “Trc2”, because we want the data from the upper right window of our VNA. The excerpt from the resulting file “S22.CSV” is shown below:

```
# version 1.00
#
freq[Hz];re:Trc2_S22;im:Trc2_S22;
1.7000000000000000E+009;-3.774877060209435E-001;2.324034080768671E-002;
1.703006012024048E+009;-3.759027275370633E-001;1.990155780128078E-002;
1.706012024048096E+009;-3.755329507400619E-001;1.957187428872192E-002;
1.709018036077144E+009;-3.751647566604542E-001;1.680047126060519E-002;
```

Script file “DL_SCR_001” as used in this example provides data in complex values including real and imaginary parts.

We can also get the format “dB magnitude / phase” which is provided by script “DL_SCR_004” as shown below:

```
# script file for NWA result file creation & download
# update: Jan 3rd, 2011

name = 'DL_SCR_004'

instr = ['ZVA', 'ZVB', 'ZVT']

descr = ""
Store data of a selected trace
to a trace file.
The trace can be selected by entering the name
of the trace into the 'trac' text box below,
examples of valid trace names: Trc1, Trc2 or Trc3.

Data is stored in dB-magnitude values,
file format: CSV = comma (semikolon) separated values

example :
freq[Hz];Isolation_S12[dB];
1.0000000000000000E+007;-5.984727135792167E+001;
1.1868750000000000E+007;-6.876953159531740E+001;
""

# Parameter:
trac = 'Trc2'
local_file = '/Users/Shared/S22_db_magn.csv' # local file with
path

# Store all trace data of Chn1 to a trace file :
instrument.write("MMEM:STOR:TRAC '{}',
'C:\\Rohde&Schwarz\\Nwa\\Traces\\lcpy_004.csv', FORM,
LOGP".format(trac))
instrument.query("*OPC?");

f = open(local_file, 'wb')
f.write(instrument.query_binary_values("MMEM:DATA?
'C:\\Rohde&Schwarz\\Nwa\\Traces\\lcpy_004.csv'", datatype='B',
is_big_endian=False, container=bytearray))
f.close()

print ("Trace Data saved at " + local_file)
```

The excerpt of the appropriate target file “S22_db_magn.csv” is as follows:

```

# version 1.00
#
freq[Hz];db:Trc2_S22[U];ang:Trc2_S22[*];
1.700000000000000E+009;-8.445513592970674E+000;1.764769849173390E+002;
1.703006012024048E+009;-8.486334213088064E+000;1.769693977322282E+002;
1.706012024048096E+009;-8.495258501115709E+000;1.770165810372596E+002;
1.709018036072144E+009;-8.506177205707246E+000;1.774361263787575E+002;
1.712024048096192E+009;-8.486334213088064E+000;1.778788214687886E+002;

```

5.3.5.2.3.3 Example 3: Download all traces from channel 2 (lower left curve of VNA display)

In this case, we select script "DL_SCR_005" as shown below:

```

# script file for NWA result file creation & download
# update: Jan 3rd, 2011

name = 'DL_SCR_005'

instr = ['ZVA', 'ZVB', 'ZVT']

descr = ""
Store a l l trace data of
selected channel to a trace file
The channel can be specified by entering the channel
number into the 'chan' text box below,
examples of valid channel numbers: 1, 2, 3

Data is stored in dB-magnitude values,
file format: CSV = comma (semikolon) separated values

example :
freq[Hz];Gain_S21[dB];Isolation_S12[dB];
1.000000000000000E+007;-6.146944734879487E+001;-
5.984727135792167E+001;
1.186875000000000E+007;-7.617222845351243E+001;-
6.876953159531740E+001;
""

# Parameter:
chan = 2
local_file = '/Users/Shared/OrangeCurve.csv' # local file with
path

# Store all trace data of Chn1 to a trace file :
instrument.write("MMEM:STOR:TRAC:CHAN {",
'C:\\Rohde&Schwarz\\Nwa\\Traces\\lcpy_005.csv', FORM,
LOGP".format(chan))
instrument.query("*OPC?");

f = open(local_file, 'wb')
f.write(instrument.query_binary_values("MMEM:DATA?
'C:\\Rohde&Schwarz\\Nwa\\Traces\\lcpy_005.csv'", datatype='B',
is_big_endian=False, container=bytearray))
f.close()

print ("Trace Data saved at " + local_file)

```

The script file now is expecting a channel number (chan). We enter “2” and press Run. The appropriate result file “OrangeCurve.csv” is as follows (excerpt) :

```
# version 1.00
#
freq[Hz];Trc3_s21[dB];
1.000000000000000E+008;-2.095064317623712E+001;
1.098196392785571E+008;-1.940879450018236E+001;
1.196392785571142E+008;-1.680944856551864E+001;
1.294589178356713E+008;-1.584605631189778E+001;
1.392785571142778E+008;-1.447127114043578E+001;
```

We get one trace “Trc3” because there is only one trace in Channel 2.

5.3.5.2.3.4 Example 4: Create and download a file in the standard s2p-format

The SxP-standard file format requires that along with two-port-networks all 4 s-parameters are concurrently measured, i.e. S11, S12, S21 and S22. For this reason, we create a new measurement setup with the VNA, where all 4 s-parameters are measured according to the figure below:

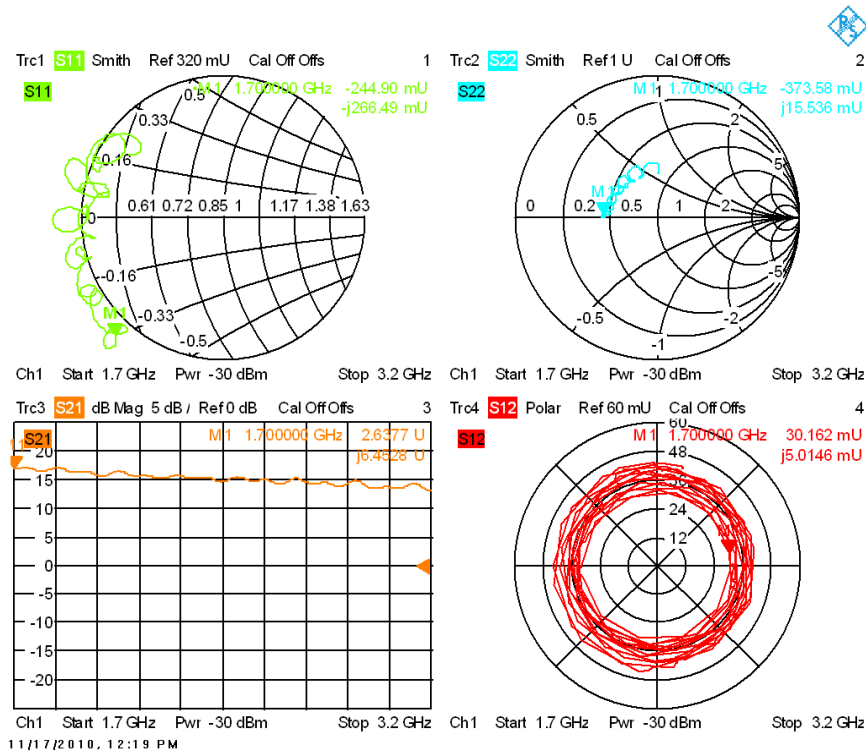

Each s-parameter is displayed in its individual window. Additionally, we have located a marker at the starting point of the sweep frequency (1.7 GHz) for each window. Each marker value is displayed in terms of its real and imaginary value in order to compare the results with the downloaded file.

The figure below shows the script window in order to download the results in standard S2P-format using RSCCommander:

```
# script file for NWA result file creation & download
# update: Jan 3rd, 2011

name = 'DL_SCR_009'

instr = ['ZVA', 'ZVB', 'ZVT']

descr = """
Store data of a selected channel
to a standard s2p file
The channel can be specified by entering the channel
number into the 'chan' text box below,
examples of valid channel numbers: 1, 2, 3
Channel default setting is 1

Data is stored according to the sxp standard file format
To generate a multiport standard file *.s2p, *.s3p...,
the channel must contain traces for the full set of S-parameters

example (excerpt, first columns only) :
4.0000000000000000E5      1.040171265602112   -1.669220440089703E-2
8.770112763158977E-4
1.7898000000000000E7      5.465688705444336E-1   -8.144427537918091E-1
3.340524155646563E-3
"""

# Parameter:
chan = 1
local_file = '/Users/Shared/xxx_009.s2p' # local file with path

# Store all trace data of Chn1 to a trace file :
instrument.write("MMEM:STOR:TRAC:CHAN {}",
'C:\\Rohde&Schwarz\\Nwa\\Traces\\lcpy_009.s2p', UNF, LOGP".format(chan))
instrument.query("*OPC?");

f = open(local_file, 'wb')
f.write(instrument.query_binary_values("MMEM:DATA?
'C:\\Rohde&Schwarz\\Nwa\\Traces\\lcpy_009.s2p'", datatype='B',
is_big_endian=False, container=bytearray))
f.close()
instrument.write("MMEM:DEL
'C:\\Rohde&Schwarz\\Nwa\\Traces\\lcpy_009.s2p'")
instrument.write("@LOC")

print ("Trace Data saved at " + local_file)
```

The appropriate result file “xxx_009.s2p” includes 9 columns of measurement data. The following excerpts provide the very first rows along with certain columns as indicated on top:

Excerpt 1: Head comments and column 1 to column 3

```

# HZ S RI R 50.00
! Rohde & Schwarz ZVA/B
!
!
!
1.700000000000000E9 -2.449026541325035E-1 -2.664936635338622E-1
1.703006012024048E9 -2.427991600855533E-1 -2.702086661344921E-1
1.706012024048096E9 -2.404476980143082E-1 -2.711796556288387E-1
1.709018036072144E9 -2.421850089319210E-1 -2.753834923997228E-1
1.712024048096192E9 -2.4084136688516926E-1 -2.768651589619244E-1

```

Column 1 includes the frequency, column 2 (-2.449...) and column 3 (-2.665...) the real and imaginary values of S11. We can compare this with the green curve in the upper left of the VNA screen shot above. The appropriate marker values show identical results for the first row in the table.

Excerpt 2: First rows of column 4 and 5

```

2.637690857118924 6.452753225241251
2.630582114102036 6.454846531600330
2.652844270801242 6.458447418080367
2.688856037062184 6.458383331086999
2.710330695667501 6.472969059751501

```

The first column (2.637...) and the second column (6.45...) provide the real and imaginary values of S21. We can compare this with the orange curve in the lower left of the VNA screen shot above. The appropriate marker values show identical results for the first row in the table, i.e. for the frequency = 1.7 GHz.

Excerpt 3: First rows of column 6 and 7

```

3.016198557086230E-2 5.014633736134001E-3
3.014837069005408E-2 5.117254587473853E-3
3.026674060390736E-2 5.100766140888684E-3
3.080418033613225E-2 4.741694929342519E-3
3.044021571815548E-2 5.081015122268218E-3

```

The first column (3.0161 ...) and the second column (5.014...) provide the real and imaginary values of S12. We can compare this with the red curve in the lower right of the VNA screen shot above. The appropriate marker values show identical results for the first row in the table, i.e. for the frequency = 1.7 GHz.

Excerpt 4: First rows of column 8 and 9

```

-3.735843871273391E-1 1.553597814186289E-2
-3.746212790875430E-1 1.393974521257652E-2
-3.714013110912109E-1 1.123632790834711E-2
-3.726732642052182E-1 1.039579387041612E-2
-3.728928647367708E-1 8.093520224991130E-3

```

The first column (-3.735 ...) and the second column (1.553...) provide the real and imaginary values of S22. We can compare this with the light blue curve in the upper right of the VNA screen shot above. The appropriate marker values show identical results for the first row in the table, i.e. for the frequency = 1.7 GHz.

By means of the markers we can easily compare the measured values with the downloaded file. Another suitable way to verify the data is by means of EDA tools like “Ansoft Designer SV” or “RFSim99” where the SxP-files can be loaded and displayed. Files of CSV-format can easily be verified using Excel where they can

be directly loaded in and where they also can be graphically displayed. Matlab® or the freely available Octave are also suitable tools for postprocessing VNA result files.

5.3.5.2.4 Frequently asked questions on trace data downloads using script files

This section covers common pitfalls and obstacles along with their solutions.

Q1: when pressing **Run** I get the “Success” message, but I can't find neither the target file nor the target directory.

A1: check whether there are hidden directories within the file system on your PC. Use the windows file explorer for this purpose and make them visible.

Q2: when repeating file download I each time get slightly different results even I do not change anything at the network analyzer.

A2: This is because the VNA is sweeping constantly and the results are overwritten for each sweep. Change the “Free Run” trigger mode at the Network Analyzer to “Manual Trigger” (SWEEP → Trigger → Manual Trigger). In this case you will get constant results for each download.

Q3: when I enter the channel name “Ch1” in order to specify the channel for download (chan parameter) I always get the message “Error 141, Invalid character ...”

A3: Channels are specified by *numbers*. Therefore, enter just the number ‘1’ if you want to download from Ch1 and enter the number ‘2’ if you want to download from Ch2 and so on.

Names and letters are only possible for the specification of a *trace*. Therefore, when selecting a trace for download you can specify the full name of the trace, ex. “Trc1” or “Trc2”.

Q4: When using script “DL_SCR_025” along with R&S®ZNB I get an “Execution Error” when trying to download the “s2p” file for a 2-port measurement.

A4: Multiport measurements always need the full set of s-parameters before result file download. Please make available the traces for S11, S22, S12 and S21 on your R&S®ZNB before starting the download.

5.3.6 Interactive Control

Allows to send commands to and receive data from the active instrument.



Figure 30: Interactive Control Window

The **Command** combo box allows editing a custom command or selecting a predefined one:

- ▶ ***IDN?** – Reads the ID string from the current device.

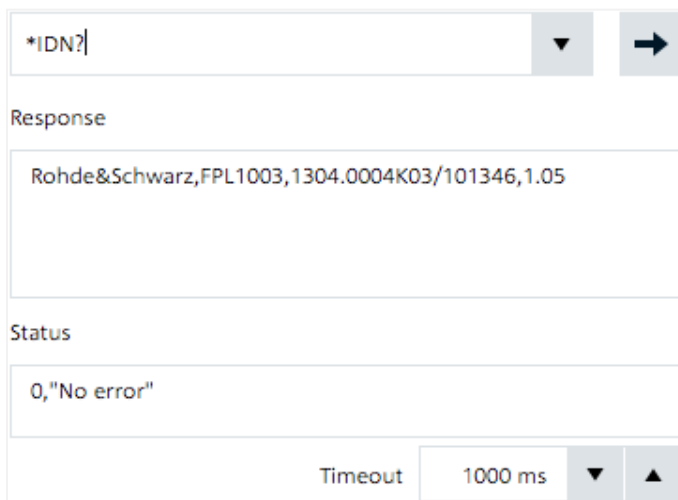

Figure 31: ID String

- ▶ ***OPT?** – Reads the list of hard- and software options.

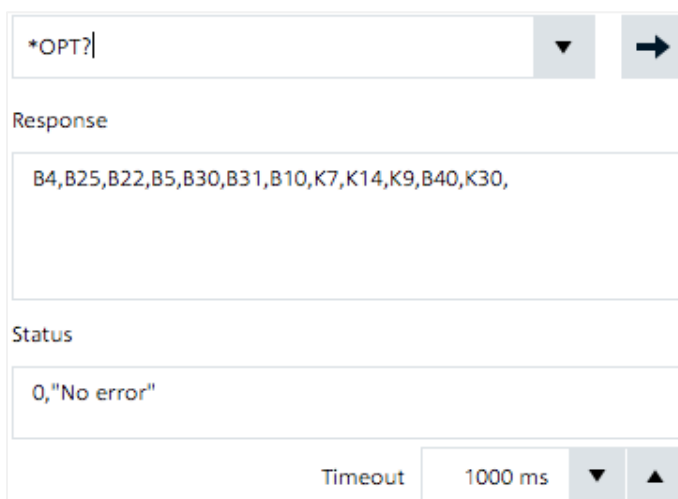

Figure 32: Hard- and Software Options

- ▶ ***CAL:RES?** – Reads the calibration results, if a calibration has previously been performed.

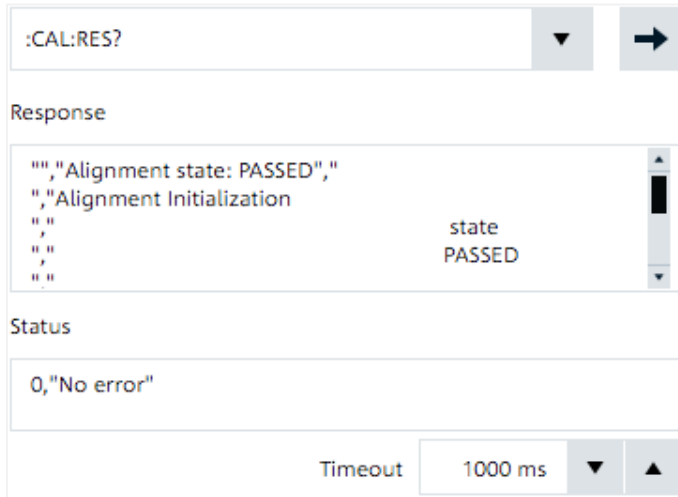

Figure 33: Calibration Results

- ▶ **DIAG:SERV:STES:RES?** – Reads the results of a self-test that has previously been performed.

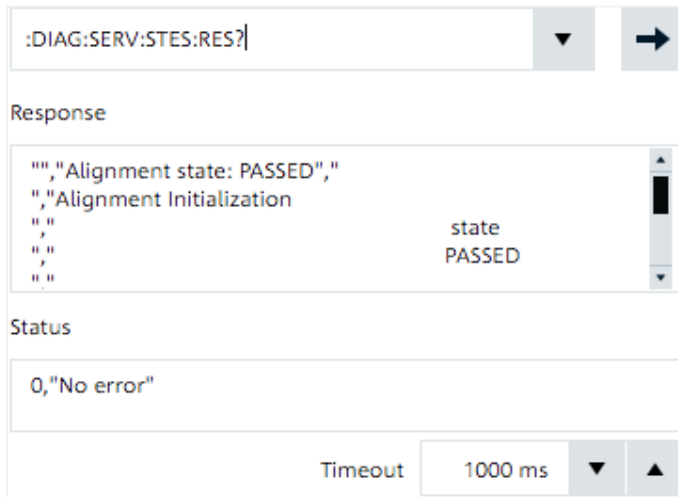

Figure 34: Selftest Results

- ▶ **DIAG:SERV:HWIN?** – Reads the hardware info.

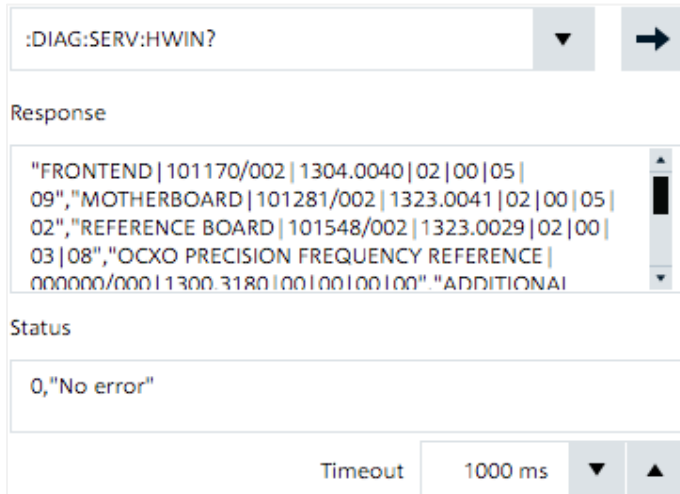

Figure 35: Hardware Info

When a command terminated with a question mark is transferred to the instrument by pressing **Send**, the answer is automatically read and displayed.

5.3.7 Settings

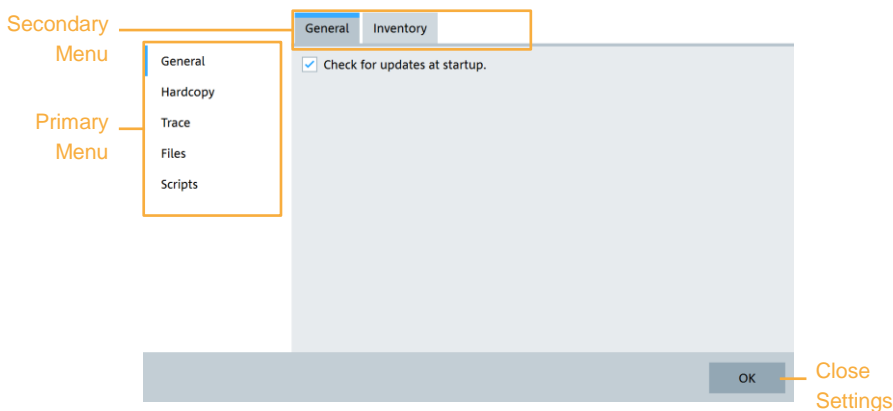

Figure 36: Settings window

The settings window has five primary categories:

5.3.7.1 General

General: Check for updates at startup

If set, the program searches for an update on the internet when RSCOMMANDER is started.

Inventory: Status Check

The automatic online check can be enabled and disabled and the Interval *I* can be set.

The program checks all *I* seconds if the devices are online and sets the status.

Note: If you have more than five instruments added to the inventory, the status scan can slow down RSCOMMANDER and other remote control activities, so we recommend turning this function off when using many devices

5.3.7.2 Hardcopy

General: Default directory for storing screenshots

The default directories for screenshots can be set by clicking the ... button on the right of the textboxes.

Note: Cause of the sandbox restrictions on macOS this is only available on Windows.

General: Store screenshots in clipboard on capture

Enables Auto-Clipboard (see 5.3.2)

General: Store screenshots in default directory on capture

Enables Auto-Save (see 5.3.2)

Note: Cause of the sandbox restrictions on macOS this is only available on Windows.

5.3.7.3 Trace

General: Default directory for storing traces

The default directories for traces can be set by clicking the ... button on the right of the textboxes.

Note: Cause of the sandbox restrictions on macOS this is only available on Windows.

General: Store traces in clipboard on new trace

Enables Auto-Clipboard (see 5.3.3)

General: Store traces in default directory on new trace

Enables Auto-Save (see 5.3.3)

Note: Cause of the sandbox restrictions on macOS this is only available on Windows.

Colors: Display colors: Curve color

Sets the color of the displayed curve

Colors: Display colors: Grid color

Sets the color of the displayed grid

Colors: Display colors: Background color

Sets the color of the displayed background of the chart

Colors: Display colors: Labels color

Sets the color of the displayed labels at the bottom as well as the labels for the maker values

Colors: Printing colors:

Sets the same color values, but for printing or saving the trace to image file

5.3.7.4 Files

General: Default directory for transferred files

The default directories for files can be set by clicking the ... button on the right of the textboxes.

Note: Cause of the sandbox restrictions on macOS this is only available on Windows.

5.3.7.5 Scripts

General: Default directory for scripts

The default directories for scripts can be set by clicking the ... button on the right of the textboxes.

Note: Cause of the sandbox restrictions on macOS this is only available on Windows.

Rohde & Schwarz

The Rohde & Schwarz electronics group offers innovative solutions in the following business fields: test and measurement, broadcast and media, secure communications, cybersecurity, monitoring and network testing. Founded more than 80 years ago, the independent company which is headquartered in Munich, Germany, has an extensive sales and service network with locations in more than 70 countries.

www.rohde-schwarz.com



Rohde & Schwarz training

www.training.rohde-schwarz.com

Rohde & Schwarz customer support

www.rohde-schwarz.com/support

